



# Desiccant dryers, heatless regenerated

## DC 12 - DC 1545 Series

From frost protection to high-tech applications

Flow rate 1.17 to 154.53 m<sup>3</sup>/min; Pressure 5 to 16 bar

# From frost protection to high-tech applications

Desiccant dryers in the DC series can lower the pressure dew point of the compressed air to  $-70\text{ }^{\circ}\text{C}$ . They combine reliable system design, high energy efficiency and extremely low maintenance costs.

Enjoy dependable frost protection for your control valves and lines while producing dry compressed air for sensitive processes at minimal cost.

## Reliable and compact

DC dryers feature high-quality components, water-resistant high-performance desiccants and generous fill levels. The ECO CONTROL BASIC, supplied as standard, monitors the drying cycle. For more comprehensive system monitoring and reporting, the network-enabled ECO CONTROL 2 controller is available as an option. All models are installed on a rugged, space-saving frame.

## High efficiency – low pressure dew points

The radial arrangement of the inlets and outlets permits an elongated tank design with compact dimensions, creating highly efficient airflow conditions for energy-efficient drying. The large-bore pipework and the efficient KAESER FILTER limit the pressure drop across the DC dryers to a maximum of 0.2 bar. The ECO CONTROL 2 dew point trend recognition control offers outstanding energy-saving potential (see page 9).

## Low-maintenance design

Thanks to the high-quality components, e.g. the valves, and the large desiccant tank, we recommend a full overhaul only every five years. This is also easy on the wallet, because the overhaul of a DC series dryer is a quick and easy process – and time is money.

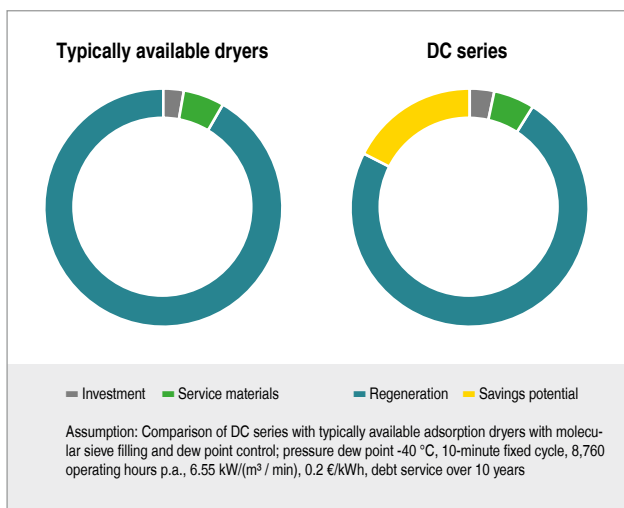

## Very low life-cycle costs

DC series desiccant dryers by KAESER achieve very low life cycle costs. For conventional models using molecular sieve desiccants, the costs for regeneration and maintenance materials are significantly higher. For a 10 m<sup>3</sup>/min dryer, this can mean potential savings of up to €90,000 over a 10-year period. Moreover, DC desiccant dryers require far fewer service calls.



Image: DC 133E - 13.33 m³/min ECO CONTROL 2 dew point trend recognition control



Image: DC 133 with high-quality oil/water separators at the compressed air inlet and purge air outlet

DC 12 – 1545 series

## Reliable and compact

Desiccant dryers are often selected for sensitive applications requiring maximum compressed air availability. To ensure the necessary reliability, DC desiccant dryers are therefore built with top-quality materials and components.



### Long-lasting desiccant tanks

In accordance with the AD regulations, the desiccant tanks are rated for a million load cycles at a 10 bar pressure differential and thus for continuous operation of at least 10 years. Internal stainless steel flow diffusers and corrosion-resistant exterior surfaces contribute to outstanding tank durability.

### Long-lasting desiccant

Unlike other dryers on the market, KAESER DC dryers are provided with a generous fill-volume of desiccant material. Moreover, the desiccant supplied with the units features outstanding crush strength and resistance to liquid water. This keeps pressure dew points reliably low even under demanding operating conditions.



### Complete regeneration

DC dryers are always equipped with two high performance silencers. The large filtering surfaces ensure dust-free and complete pressure reduction, substantially enhancing regeneration efficiency. An integrated overload valve indicates when maintenance is needed. In addition, DC dryers are available with a special sound insulation option.

### Rugged and compact design

Thanks to a robust frame with an earthing screw, DC dryers are fully protected and easy to transport (equipped with a lifting eye from size DC 169 upward). The units up to size DC 133 are impressively compact.

# Low-maintenance design

KAESER understands customers' needs, as the company itself operates various compressed air stations. From first hand experience, we are well-versed in all aspects of compressed air station planning, implementation, operation and maintenance. We draw on this expertise to create user-friendly and low-maintenance products.



## Long desiccant service life

Thanks to the premium quality and excellent crush strength of the desiccant material, combined with the generous fill-volume, we can guarantee an outstanding five-year operational period. Its physical stability in the presence of free water also means that DC dryers generally need to be filled only once. This eliminates the risk of mistakes when servicing the tank or mixing desiccant material to refill it.



## Service-friendly valve technology

The valves and flaps in DC dryers are specifically designed for wide fluctuations in pressure loads and low pressure losses. Thanks to the excellent quality of these units, they generally require maintenance only after five years. In addition, maintenance of the airflow-optimised single-port valves and flaps is much easier and more reliable than with the more common multi-port valves.



## Easy filling and emptying

The radial arrangement of the tank inlets and outlets enables easy and straightforward desiccant replacement using the large connectors. The connectors are also easily accessible for tank inspections.



## Important pressure levels at a glance

The front panel of every DC dryer is fitted with three pressure gauges to display the tank pressures and the inlet pressure at the purge air orifice. Another pressure gauge at the rear of the unit makes it easier to set the regeneration flow rate.



Aluminium shuttle valve and moisture indicator (with separate non-return flaps from size DC 169). The valve technology permits the inflow of dried compressed air for regeneration when the system is shut down – with no need for a return air line!



**DC 133**

**KAESER**

Image: DC 133E with  
ECO CONTROL 2 and  
pressure gauges –  
user-friendly layout of  
control elements



# High efficiency – low pressure dew points

Achieving pressure dew points below 0 °C is always a challenge. That makes it even more important to draw on our decades of experience in the design of our DC desiccant dryers and use high-quality components throughout. This ensures outstanding energy efficiency across the entire performance range.



## Long desiccant tanks

The radially mounted piping provides a compact system design with a maximum tank length. This maximises the duration of contact between the compressed air and the desiccant, thus ensuring optimal use of the desiccant capacity. It also results in material-friendly airflow speeds. This saves on purge air and reduces service costs.



## Very low pressure losses

Thanks to large-bore pipework and the efficient KAESER filters, DC dryers deliver standout performance with a maximum pressure loss of 0.2 bar. Due to the high dust retention capacity of the pleated filter elements, pressure loss remains low throughout the service life of the element.

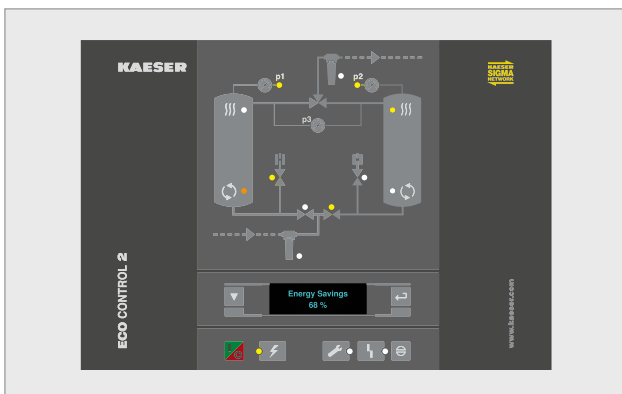

## Dew point trend recognition control

DC dryers are available with the **ECO CONTROL 2** dew point trend recognition control. Through the demand-based utilisation of purge air, it offers substantial energy saving potential under partial load conditions. It also offers comprehensive system monitoring and reporting and a modbus TCP interface connection to the KAESER SIGMA NETWORK.

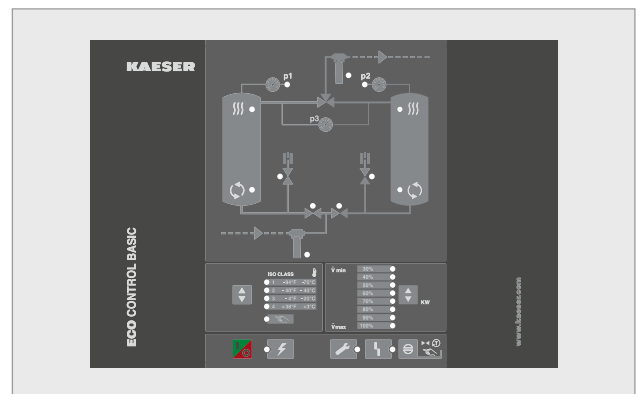

## Cyclic savings

With the **ECO CONTROL BASIC** controller, the DC dryers operate in a material-friendly 10-minute cycle that can be adjusted manually depending on the dryer workload. This means, for example, that if a dryer is “upsized” – perhaps with a view to expanding the compressed air station at a future date – the cycle can be adjusted to save purge air.





DC 27

**KAESER**

# How it works

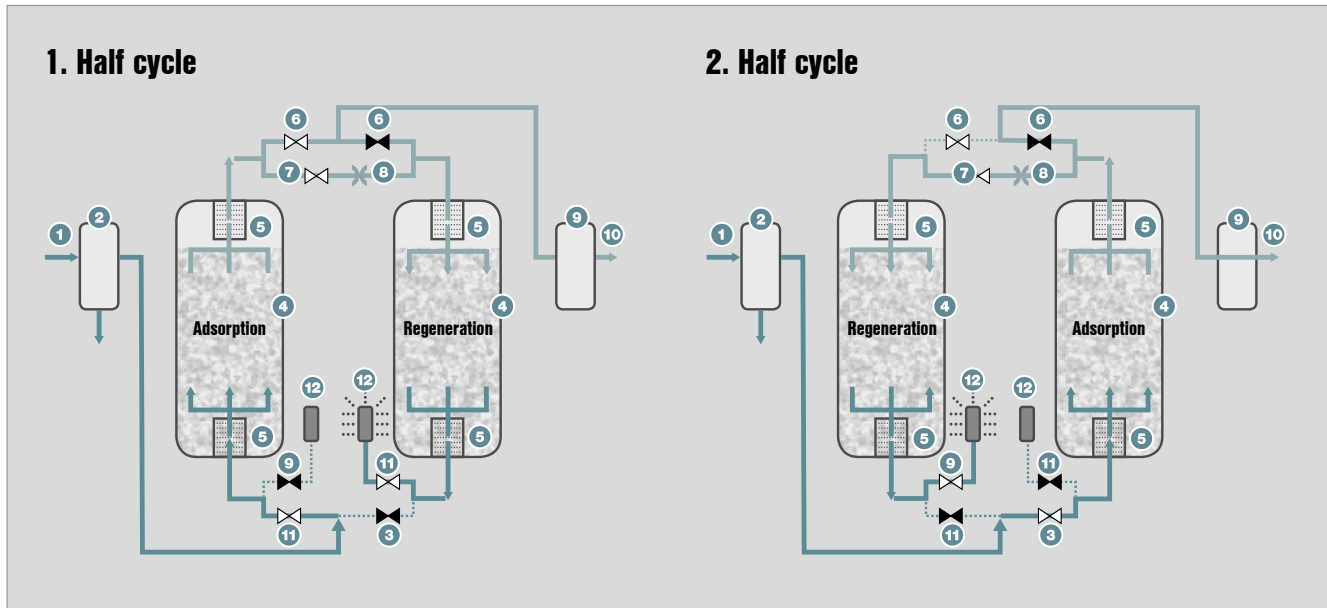

- |                                   |                                |
|-----------------------------------|--------------------------------|
| (1) Compressed air inlet          | (7) Purge air adjustment valve |
| (2) Pre-filter                    | (8) Purge air orifice          |
| (3) Compressed air inlet valve    | (9) Afterfilter                |
| (4) Desiccant tank with desiccant | (10) Compressed air outlet     |
| (5) Flow diffusers                | (11) Purge air discharge valve |
| (6) Compressed air check valve    | (12) Silencer                  |

Desiccant: activated aluminium oxide

## The right choice – with certainty!

The DC series uses only activated aluminium oxide – a highly crush-resistant material with excellent mechanical stability that requires minimal regeneration energy. Compared with molecular sieve dryers, for example, DC series dryers typically require up to 20% less purge air to maintain a pressure dew point of  $-40\text{ }^{\circ}\text{C}$ .

In addition, only top-quality desiccants are used, consisting of uniform beads with minimal dust formation. This ensures that the desiccant bed channels remain dust free even with shifting airflows for maximum capacity utilisation. Thanks to the stability of the desiccant material in the presence of liquid water, multi-stage filling can also be dispensed with in DC series desiccant dryers. Apart from making it easier to service them, it also enhances

operational safety under extreme working conditions. In such cases, it absorbs significantly less water than other desiccants without softening or disintegrating and can be regenerated quickly, permitting a faster return to the original pressure dew point.

Last, but not least, it can be changed at relatively moderate cost.

# High efficiency – low pressure dew points

The ECO CONTROL 2 saves considerable energy especially with variable flow rates, pressures or temperatures. The dew point trend recognition control is more cost-effective and secure than conventional dew point controllers since it reacts to changes in the desiccant temperature differential instead of responding only when the pressure dew point at the dryer outlet increases.

New measurements and relative temperature difference comparisons are carried out for each new cycle. Since tank switchover occurs only when the desiccant is used to its full potential, the adsorption phase can be extended by up to 30 minutes, based on workload, to save purge air.

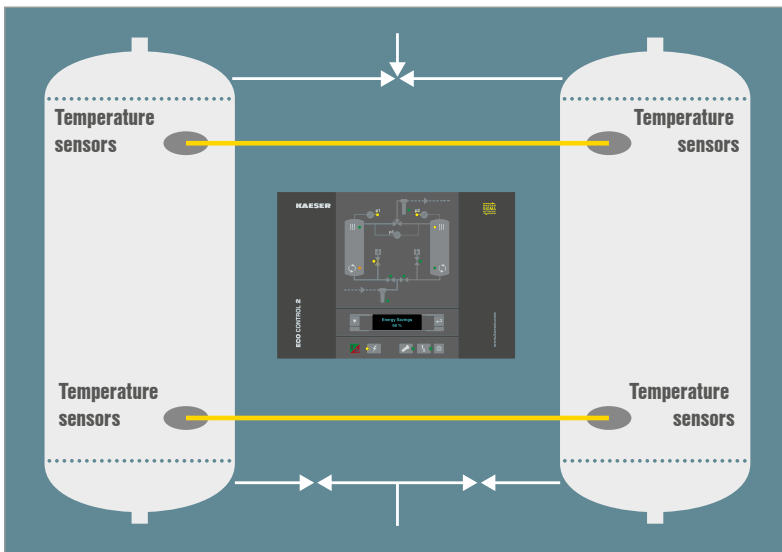

## Key benefits

- The need for a costly pressure dew point measuring device is eliminated.
- Associated regular calibration and maintenance costs are therefore also eliminated.
- Unlike dew point measuring devices, temperature sensor functionality can be easily checked thanks to reliable open circuit monitoring.





# Stop wasting energy!

Heatless regenerating desiccant dryers should always be sized for maximum compressed air flow, the highest possible inlet temperature and minimal operating pressure. This ensures that the desired pressure dew point is maintained across the entire operating range of the compressed air station. Under real-world conditions, however, compressed air needs, ambient temperatures and network pressure will deviate from the originally specified parameters. The ECO CONTROL 2 dew point trend recognition control responds automatically to these variations and adjusts the dryer's regeneration cycle to the prevailing conditions. **The result: no more waste of dried compressed air as purge air, and a pressure dew point at the desired level.**

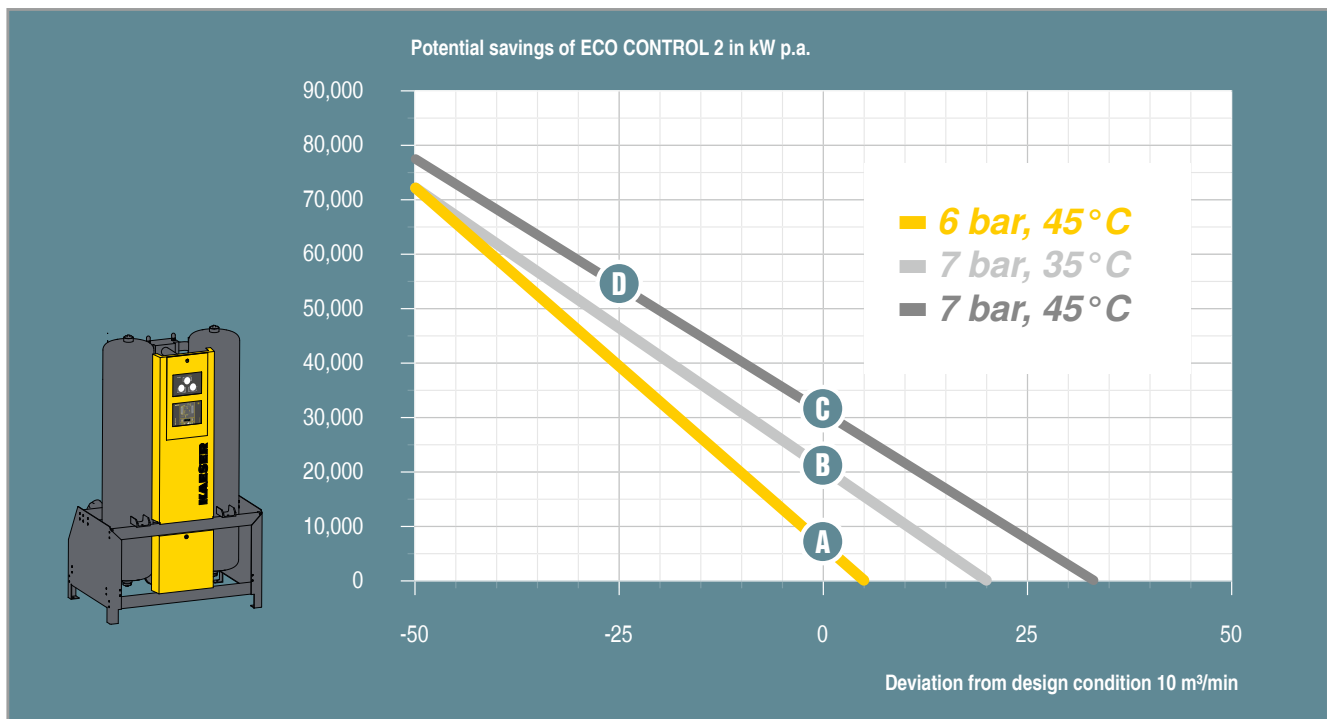

## Operating point (A)

The graph illustrates the effect: using the DC 133E desiccant dryer, air is to be dried at a rate of 10 m³/min **at 6 bar and 45 °C** to a pressure dew point of -40 °C. If the dryer runs for 8,760 hours, the ECO CONTROL 2 will save approx. 7,000 kW\* compared to a system without dew point control.

## Operating point (B)

With **inlet pressure at 7 bar** (e.g. due to a lower actual pressure drop in case of optimal maintenance), less moisture-laden compressed air will enter the dryer due to the lower volume. The ECO CONTROL 2 reduces the required purge air volume, thereby saving almost 21,000 kW p.a.

## Operating point (C)

If the dryer can be operated at an **inlet temperature of 35 °C** (e.g. in winter), further savings are possible, because the compressed air will then absorb even less moisture per m³. Here, too, the ECO CONTROL 2 controller reduces the volume of purge air according to actual requirement. Depending on the operating duration at this temperature, potential savings of up to 31,000 kW p.a.\* are possible.

## Operating point (D)

The ECO CONTROL 2 generates savings even if **compressed air requirement deviates from 10 m³/min**. The potential savings can be determined from the graphs corresponding to the respective operating points. For example, if the dryer is operated at 7 bar, 35°C and 7.5 m³/min (-25% deviation), the potential annual savings exceed 58,000 kW\*.

\* Basis: Specific power of the compressor 6.55 kW/(m³/min)

**DC 1545**

**KAESER**



## ECO CONTROL 2

# Dew point trend recognition control

### Dew point control

#### Saving energy with trend recognition

For pressure dew points down to  $-40\text{ }^{\circ}\text{C}$ , maintenance-free temperature sensors monitor the moisture content of the desiccant. The system switches to the purge tank, before the pressure dew point at the dryer outlet rises, only after optimal utilisation of the desiccant, but within 30 minutes. This minimises the need for purge air.

### Inputs and outputs

#### Expansion possible

The ECO CONTROL 2 has an inlet port for a Pt100 sensor to monitor the compressed air inlet temperature. A 4-20mA analogue input can be used to connect the differential pressure transducer of a filter. Another 4-20 mA analogue input, with its complementary output signal, is available to connect a pressure dew point sensor.

### Valve control

#### Switching sequence monitoring

ECO CONTROL 2 controls and monitors the valve switching sequence. The correct sequence can also be checked in a manual testing mode.

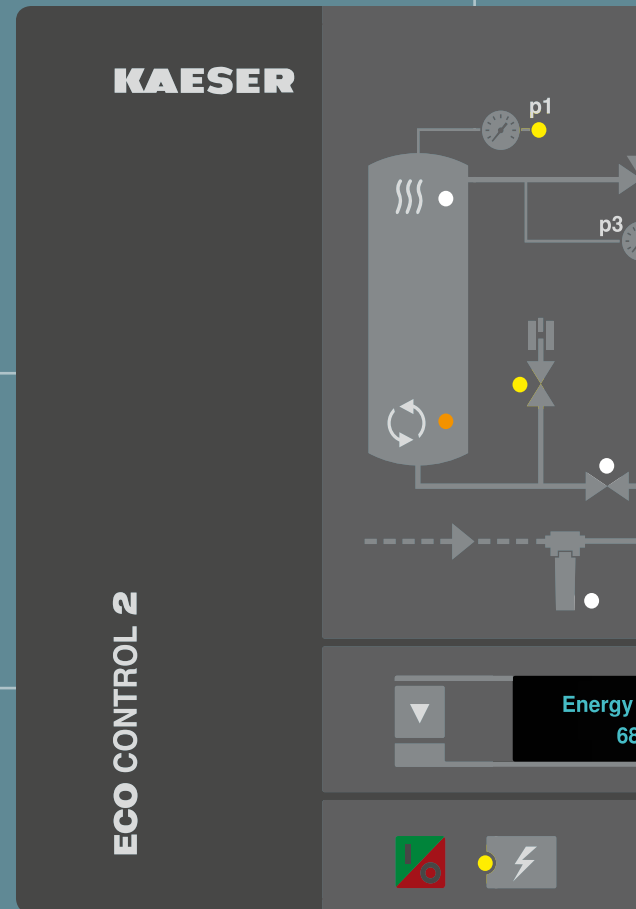

Power supply 95-240 V  
 $\pm 10\%$  / 1 Ph / 50 - 60 Hz

### Message archive

#### Onsite system diagnostics

The ECO CONTROL 2 can log 20 system messages, using a buffered real-time clock to log them with the time and date. Detailed analysis is also possible through a link to the SIGMA NETWORK.



## Network connection

### The path to the SIGMA NETWORK

ECO CONTROL 2 is equipped as standard with the Modbus TCP communications module. This permits communication with SIGMA AIR MANAGER 4.0.

## Flow diagram

### The drying process visualised

Units feature an easy-to-read display panel with visual system overview and LEDs on the pressure switch, valve, and tank icons to provide clear, precise information regarding operational and servicing status.

## USB interface

### Simple updates

The USB port makes it very easy to update the control software.

## Floating contacts

### The hotline

Contacts are available for fault alerts, warnings and operational messages (one contact for each). In addition, two contacts are available to connect the alarm messages from two condensate drains. The remote control (completion of half a cycle before shutdown) can also be operated via a separate contact.

## Plain text display

### Speaks your language

The two-line plain text display facilitates easy operation and efficient system monitoring. The ECO CONTROL 2 currently supports 13 languages.

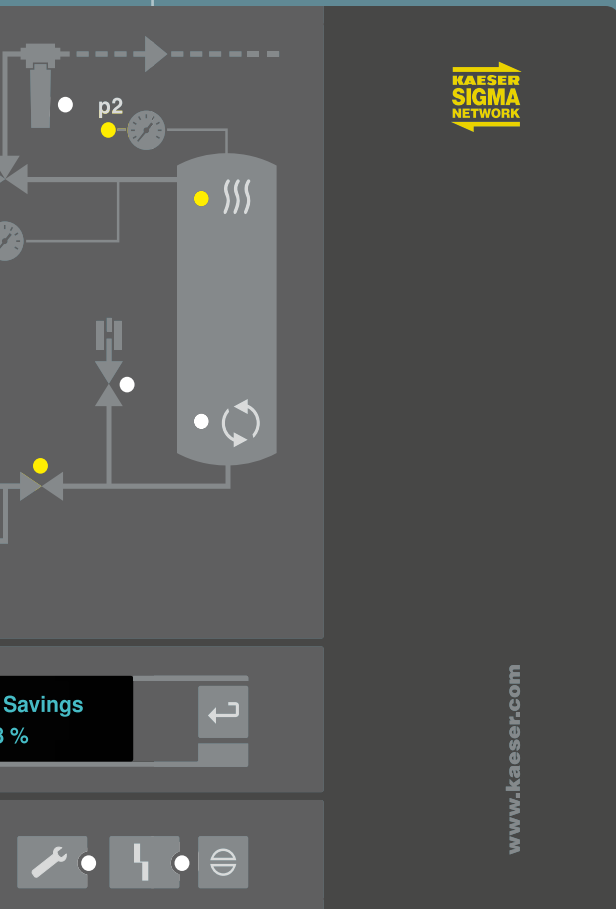

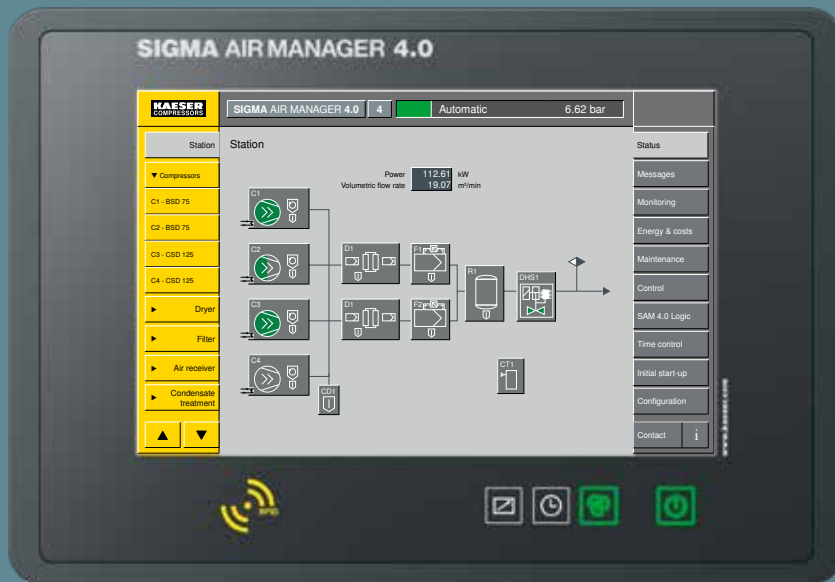

SIGMA AIR MANAGER 4.0

# KAESER SIGMA NETWORK

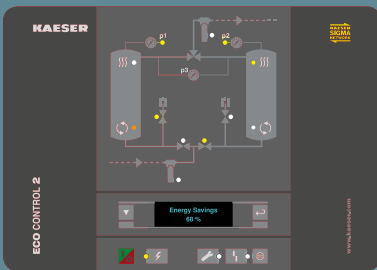

ECO CONTROL 2

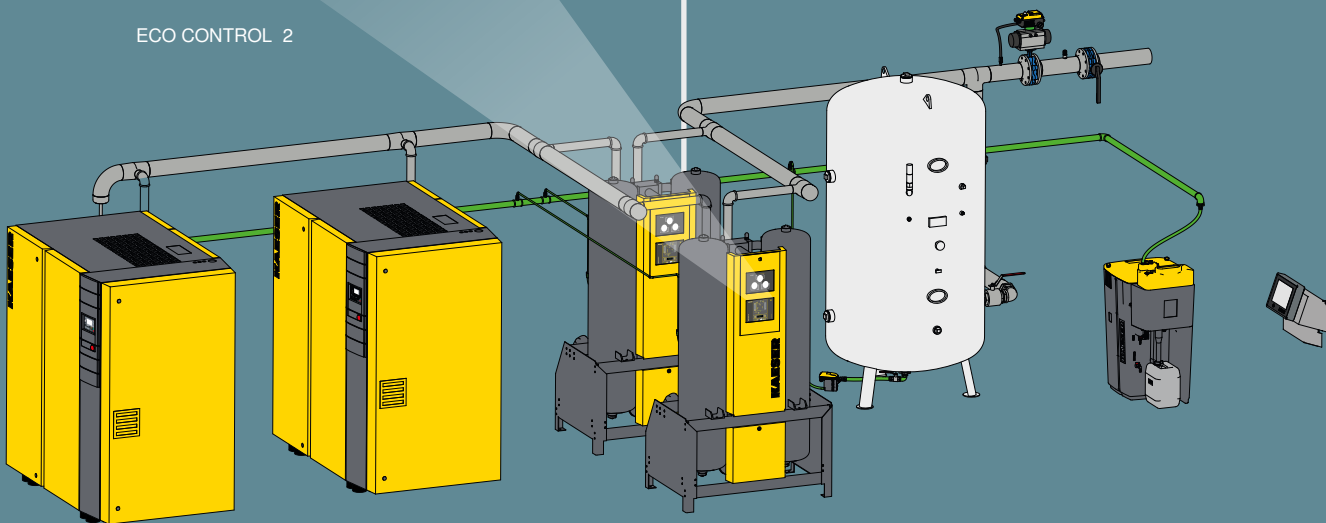

Networked compressed air station

# Compressed air management technology 4.0 from KAESER

Industrie 4.0 – the key term for the fourth industrial revolution. In addition to the focus on “individualised production processes” and “product-related information exchange”, a further factor is becoming increasingly important: time – because time is money.

Industrie 4.0 is based on digital information technology, interconnecting people and machines, equipment and components. This technological revolution also embraces real-time information exchange – the transfer and analysis of data in real-time. It is this capability that provides the decisive competitive advantage. The technology also opens up new value-added potential by ensuring permanent utility and availability, for example, of important industrial equipment.

## Identify, analyse, react – in real-time

The SIGMA AIR MANAGER 4.0 is the core of the SIGMA NETWORK and is KAESER's key technology for Industrie 4.0. As the central mastermind, it controls the entire compressed air supply system and – via KAESER IoT clients (Internet of Things) – is responsible for data streaming to the centralised KAESER SIGMA SMART AIR application. Process data from the compressed air system in the SIGMA NETWORK is transmitted in real-time. Specialised software ensures continuous system evaluation and dependable data transmission to control centres or user end devices.

Centralised compressed air system monitoring is performed in the KAESER DATA CENTER and it is here where warning, maintenance, alarm and operational messages, as well as energy management, analyses and reports for optimised system performance are processed.

## KAESER SIGMA SMART AIR: Predictive maintenance

The combination of remote diagnostics and needs-based, preventative maintenance helps ensure maximum compressed air supply dependability. Through permanent availability of compressed air system process data and the resulting continuous analysis, it is possible to identify the perfect point in the future when your compressed air supply system should be maintained and serviced. This prevents costly periods of unscheduled downtime, increases energy efficiency (thanks to monitoring of key parameters) and allows compressed air system performance to be precisely matched to demand throughout the entire life cycle of the system.

This combination of remote diagnostics and demand-oriented preventative maintenance ensures maximum availability and potentially reduces service costs by up to 30%.

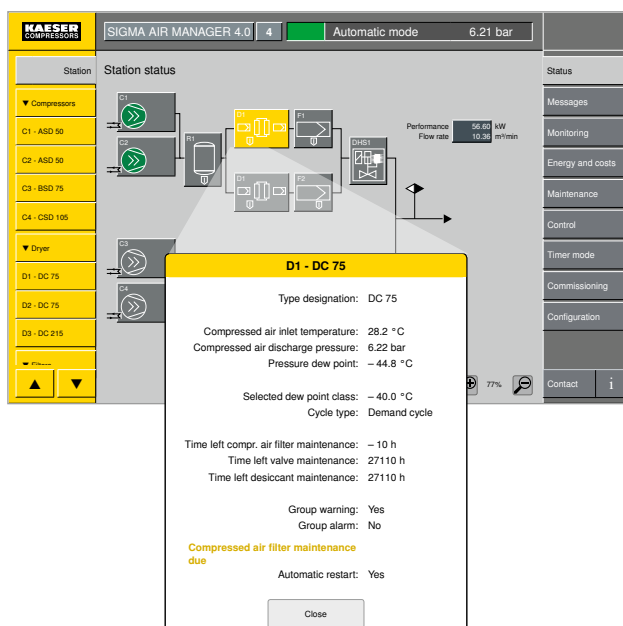

## Industrie 4.0 ready!

The ECO CONTROL 2 controller features an integrated Modbus TCP interface. This makes it possible to connect DC series dryers to the SIGMA NETWORK. All essential operational parameters and messages are available in real-time. The result: maximum availability with minimal costs. In addition, the SIGMA AIR MANAGER 4.0 provides a complete overview of all essential operating parameters of the desiccant dryers. Colour-coded warnings and alarms are displayed in the compressed air station's P&I diagram. By pressing the dryer icon, the user can display important operating parameters and message texts in SIGMA AIR MANAGER 4.0.

# Reliable, service-friendly and efficient

## High-performance desiccant tanks

AD regulation – continuous operation > 10 years; outer coating (DIN EN ISO 12944 C2); stainless steel diffusers; maximum tank length and compact system design thanks to radial placement of pipework (material friendly airflow speeds; optimal contact time for best possible utilisation of desiccant capacity; low purge air requirements).

## Minimal purge air volume

Two openings for optimal adjustment to the operational pressure range; exact flow rate setting using inlet pressure at purge air orifice using valve and pressure gauge.

## KAESER FILTER: low pressure loss

Generous nominal widths; contributes to low overall system pressure loss: max 0.2 bar; KE coalescence filter as pre-filter for max. desiccant service life; pre-filter with ECO-DRAIN 31; KD particulate filter as after-filter catches abraded desiccant material; from size DC 169 with flange connection.

## High-quality valve technology

Recommended maintenance interval: five years; maintenance of single-port valves is simple and reliable; low pressure losses – lower than with multi-port valves; generous nominal widths; aluminium shuttle valve up to size DC 133; designed for fluctuating pressures; configurable valve settings in case of power outage; dry air return as purge air without return air line (intermittent operation).

## Stable frame

Easy and safe transport; equipped with a lifting eye from size DC 169 upward.

## Important pressure readings at a glance

Front: pressure levels in both tanks; inlet pressure at purge air orifice; rear: inlet pressure at purge air orifice.

## ECO CONTROL 2 – network-enabled

Dew point trend recognition control without service-intensive pressure dew point sensor; substantial potential energy savings under partial load conditions; integrated interface for connection to the KAESER SIGMA NETWORK; comprehensive system monitoring and reporting.

## Easy filling and emptying

Separate openings to fill and empty the tank; easy access for tank inspections.

## Efficient desiccant

Generous filling volumes; easy regeneration; recommended replacement interval: five years; dust-free premium quality; uniform bead size; stable in the presence of liquid water; single-layer filling; excellent crush strength.

## Complete regeneration

Two highly effective silencers; generous filter surfaces; with overload valve.



## ACT: activated carbon adsorber

Available in sizes from DC 12 upwards, DC dryers are equipped with an ACT activated-carbon adsorber that is precisely matched to meet dryer capacity. This enables production of oil-free compressed air that meets the highest quality standards (ISO 8573-1 Class 1 residual oil content). The frame construction (up to DC 133) makes it easy to connect the ACT activated carbon adsorber.



**10** minute cycle  
Pressure dew point  
- 40°C



### Soundproofing option $\leq 85$ dB(A)

DC desiccant dryers are optionally available in a special version with enhanced soundproofing. This reduces the air discharge sound levels to a maximum of 85 dB(A). In addition, models up to DC 133 size with mesh base are equipped with a housing lined with acoustic foam. From model DC 169 and upward, the two silencers are housed in a special silencing cabinet.

# Equipment

## Base frame

Base frame with earthing screw; lifting eye (from DC169).

## Prefilter

KAESER KE coalescence filter with mechanical differential pressure gauge and ECO-DRAIN electronic condensate drain; filter mounted on dryer; condensate drain electrically connected; alert warning linked to group warning (DC-E version only).

## Compressed air inlet pipe – lower pipe bridge

Piping system with two compressed air inlet valves per tank (up to DC 133: oil/water separators, from DC 169 upward: actuated butterfly valve) and their associated quick venting valves (for DC 50 to 133), two purge air discharge vents and two silencers.

## Desiccant tank

Two desiccant tanks with easily accessible filling and emptying openings; each with stainless steel diffusers and desiccant filling.

## Compressed air discharge pipe – upper pipe bridge

Piping system with shuttle valve (up to DC 133) or two non-return flaps (DC 169 and upward) and moisture indicator.

## Particulate filter

KAESER KD dust filter with mechanical differential pressure gauge and manual condensate drain; filter mounted on dryer.

## Purge air diverter

Piping system comprising two non-return flaps (DC 169) or two non-return flaps (from DC 215 upward), a valve to set the purge air quantity, a pressure gauge (DC 169 and from DC 601 upward) and two purge air orifices; flap for pressure dew points -40, -20, +3 °C and gauge pressure up to 10 bar and for pressure dew point - 70 °C pre-assembled.

## Control air supply

Pressure regulator and pressure gauge as well as valve block for control air supply of internal valves and flap actuators.

## Two-part front panel

Tank pressure gauge; inlet pressure gauge at purge air orifice; ECO CONTROL Basic or ECO CONTROL 2 controller (DC-E version).

## Floating contacts

Group alarm, remote control; with ECO CONTROL 2, also: operational alarm, group alarm.

## Sensor / electrical systems

Monitoring pressure switch to monitor venting pressure in each desiccant tank (two temperature sensors per desiccant tank (ECO CONTROL 2); electrical equipment in compliance with EN 60204-1; IP54 protection rating; 2m power cable with plug (CEE 7/7); halogen-free wiring throughout; pressure gauge on front panel connected via Tecalan tubes.

## Views



# Technical specifications

## Models DC 12 to 1545

Model	Flow rate <sup>1)</sup> m <sup>3</sup> /min	Operating pressure bar	Pressure drop <sup>1)</sup> bar	Compressed air connection	Ambient temperature °C	Max. temp. at compressed air inlet °C	Dimensions W x D x H mm	Mass kg
DC 12	1.17	5 ... 16	≤ 0.2	G ¾	2 ... 45	2 ... 50	750 x 750 x 1950	181
DC 18	1.83	5 ... 16	≤ 0.2	G ¾	2 ... 45	2 ... 50	750 x 750 x 1950	220
DC 27	2.67	5 ... 16	≤ 0.2	G ¾	2 ... 45	2 ... 50	750 x 750 x 1970	308
DC 33	3.33	5 ... 16	≤ 0.2	G 1 ¼	2 ... 45	2 ... 50	1150 x 750 x 1980	398
DC 50	5.00	5 ... 16	≤ 0.2	G 1 ¼	2 ... 45	2 ... 50	750 x 1150 x 1980	421
DC 75	7.50	5 ... 16	≤ 0.2	G 1 ¼	2 ... 45	2 ... 50	750 x 1150 x 1990	531
DC 108	10.83	5 ... 16	≤ 0.2	G 2	2 ... 45	2 ... 50	750 x 1150 x 1990	650
DC 133	13.33	5 ... 16	≤ 0.2	G 2	2 ... 45	2 ... 50	750 x 1150 x 2000	815
DC 169	16.88	5 ... 10	≤ 0.2	DN 80	2 ... 45	2 ... 50	1500 x 1320 x 1910	965
DC 215	21.47	5 ... 10	≤ 0.2	DN 80	2 ... 45	2 ... 50	1500 x 1420 x 1921	1275
DC 266	26.62	5 ... 10	≤ 0.2	DN 80	2 ... 45	2 ... 50	1500 x 1470 x 2090	1525
DC 323	32.33	5 ... 10	≤ 0.2	DN 80	2 ... 45	2 ... 50	1500 x 1520 x 2116	1710
DC 386	38.63	5 ... 10	≤ 0.2	DN 100	2 ... 45	2 ... 50	1500 x 1720 x 2136	2080
DC 444	44.35	5 ... 10	≤ 0.2	DN 100	2 ... 45	2 ... 50	1700 x 1770 x 2225	2305
DC 601	60.01	5 ... 10	≤ 0.2	DN 100	2 ... 45	2 ... 50	1950 x 1920 x 2258	2755
DC 859	85.85	5 ... 10	≤ 0.2	DN 150	2 ... 45	2 ... 50	2400 x 2140 x 2456	4105
DC 1173	117.33	5 ... 10	≤ 0.2	DN 200	2 ... 45	2 ... 50	2690 x 23350x 2701	6200
DC 1545	154.53	5 ... 10	≤ 0.2	DN 200	2 ... 45	2 ... 50	2820 x 2504 x 2536	6800

<sup>1)</sup> As per ISO 7183, option A1: Point of reference: 1 bar(abs), 20 °C, 0 % relative humidity; operating point: pressure dew point -40 °C, working pressure 7 bar(g), inlet temperature 35 °C, ambient temperature 20 °C, 100 % relative humidity Electrical supply: 95-240 V ±10% / 1 Ph / 50 - 60 Hz

## Options

Mechanical components	DC 12 to 133	DC 169 to 1545
16 bar operating pressure	Standard	Optional
System enclosure	Optional	-
Indoor installation to -20 °C, consisting of system enclosure with resistance heating	Optional	-
Sound insulation ≤ 85 dB(A): DC 12 - 133: Enclosure lined with acoustic foam and mesh base DC 169 - 1545: Silencer in sound enclosure; please note: larger footprint	Optional	Optional
Paint option: yellow components in RAL colour	Optional	Optional
Painted in corrosion class C3 – medium (160 µm, DIN EN ISO 12944); includes painting of exterior surfaces of system housing and desiccant tank	Optional	Optional
Silicone-free as per VW test standard PV 3.10.7	Optional	Optional
Equipped with one safety valve per desiccant tank	Optional	Optional
Special pressure vessel inspections (e.g. ASME) upon request	Optional	Optional

## Calculating flow rate

Correction factors for deviating operating conditions (flow rates in m<sup>3</sup>/min x k...)

Deviating working pressure p at dryer inlet												
p bar <sub>(g)</sub>	5	6	7	8	9	10	11	12	13	14	15	16
k <sub>p</sub>	0.75	0.88	1.00	1.06	1.12	1.17	1.22	1.27	1.32	1.37	1.41	1.46

Compressed air inlet temperature T <sub>i</sub>						
Temperature (°C)	25	30	35	40	45	50
k <sub>t</sub>	1.00	1.00	1.00	0.96	0.90	0.83

Example:				
Working pressure	8 bar	->	Factor	1.06
Compressed air inlet temperature	40 °C	->	Factor	0.96

KAESER FILTER F 880 with flow rate of 88.50 m <sup>3</sup> /min	
Max. possible flow rate under following operating conditions	
$V_{\max \text{ Operation}} = V_{\text{Reference}} \times k_p \times k_t$	
$V_{\max \text{ Operation}} = 88.50 \text{ m}^3/\text{min} \times 1.06 \times 0.96 = 90.06 \text{ m}^3/\text{min}$	

# The world is our home

As one of the world's largest compressed air system providers and compressor manufacturers, KAESER KOMPRESSOREN is represented throughout the world by a comprehensive network of branches, subsidiary companies and authorised partners in over 100 countries.

With innovative products and services, KAESER KOMPRESSOREN's experienced consultants and engineers help customers to enhance their competitive edge by working in close partnership to develop progressive system concepts that continuously push the boundaries of performance and compressed air efficiency.

Moreover, the decades of knowledge and expertise from this industry-leading system provider are made available to each and every customer via the KAESER group's global computer network.

These advantages, coupled with KAESER's worldwide service organisation, ensure that every product operates at the peak of its performance at all times and provides maximum availability.



## KAESER KOMPRESSOREN SE

P.O. Box 2143 – 96410 Coburg – GERMANY – Tel +49 9561 640-0 – Fax +49 9561 640-130  
e-mail: [productinfo@kaeser.com](mailto:productinfo@kaeser.com) – [www.kaeser.com](http://www.kaeser.com)