



Oil-free compression rotary screw compressors

CSG-2, DSG-2, FSG-2 Series

Flow rate up to 51 m³/min, Pressure 4 to 10 bar

Durable and clean-running for sensitive processes

Two-stage oil-free compression rotary screw compressors from KAESER not only impress with their intelligent component layout, but also with their many innovative details – all of course with the renowned KAESER quality and distinctive, contemporary design. Whether for the semiconductor, foodstuff or automotive industries: our two-stage dry-running compressors tirelessly prove that process-appropriate purity and cost-effectiveness really can go hand in hand – even under adverse conditions.

Long-term efficiency

Compressed air simply has to be available wherever and whenever it is needed. KAESER oil-free compression rotary screw compressors are therefore built to last and to ensure many years of dependable performance. Comprising tried and tested components that have been developed as a result of KAESER's near century of experience in mechanical engineering, KAESER compressors deliver the durability and compressed air availability to meet even the toughest of demands.

Innovation you can trust

Using all of the advantages that KAESER's advanced Research and Development Centre in Coburg has to offer, KAESER's engineers designed every detail of the two-stage oil-free compression rotary screw air end with maximum efficiency and performance in mind. Further additional system features include the use of fibre-free pulse dampers and, with water-cooled compressor packages, an integrated heat recovery module.

Efficiency as standard

KAESER quality and expertise really count when it comes to those all-important total system costs for asset investments such as compressors or complete compressed air supply systems. Lowest possible compressed air costs and maximum availability can be guaranteed only through a combination of perfect interplay between energy efficiency and service / maintenance, and by viewing the compressed air supply system as a whole.

Service-friendly

Right from the outset, these versatile systems were designed for maximum ease of servicing. Fewer wearing parts and the use of premium-quality materials ensure reduced maintenance requirement, longer service intervals and extended service life. Excellent component accessibility as a result of generously-sized maintenance doors and a swing-out cooler are just some of the features that make servicing so effortless.

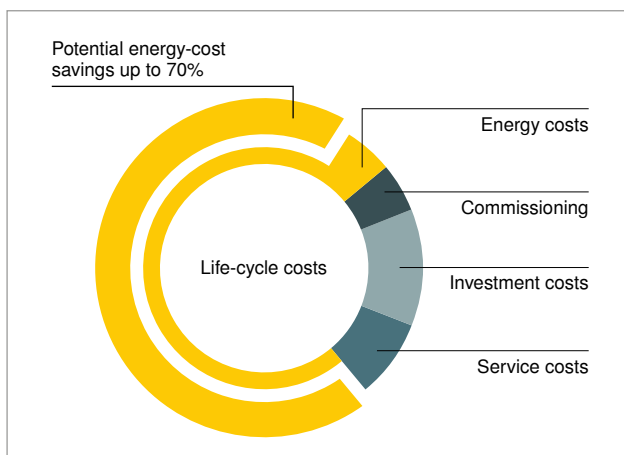

Energy-efficiency: the essential requirement

Investment and service costs account for only a small part of a compressor's total life-cycle costs. Since energy accounts for the lion's share of those costs, why not save with KAESER Life-Cycle Management? KAESER has been committed to minimising your energy costs for compressed air production for over 40 years. We also have the bigger picture in clear focus when it comes to service and maintenance, as well as maximum compressed air supply availability.

Contents



Drive systems	04-05
SIGMA CONTROL 2 and SIGMA AIR MANAGER 4.0	06-07
Service-friendly design	08-09
Compressors with i.HOC	10-13
Compressors with air-cooling	14-15
Compressors with water-cooling.....	16-17

Heat recovery

Why recover heat?.....	18-19
Technical implementation of integrated heat recovery	20-21

Compressed air drying

Process technology - Overview	22-23
Compressors with integrated refrigeration dryer.....	24-25

Technical specifications

Compressors with air-cooling	26-27
Compressors with water-cooling.....	28-29

Equipment and options

Equipment	30
Options	31

Drive systems

Fixed speed, fixed flow rate.

Base load

Base load compressors from KAESER are designed to run at one optimal operating speed. Operating at the highest levels of efficiency, they deliver a constant air volume at a fixed motor speed, making them ideally suited for applications with a constant or lightly fluctuating air demand.

Committed to meeting your objectives

Base load compressors stand out for their functional, durable drive technology and supreme levels of efficiency.



Super Premium Efficiency IE4

When it comes to base load compressors, SUPER PREMIUM EFFICIENCY IE4 asynchronous motors guarantee the highest possible efficiency levels, thanks to their well-established, durable technology and renowned service-friendliness.

Variable speed, variable flow rate.

Peak load

Maximum flexibility and sustainability: thanks to their variable-speed drive motors, peak load compressors from KAESER always deliver the exact volume of compressed air actually required. This means that they are particularly efficient in applications with a varying air demand.

Committed to meeting your objectives

Peak load compressors stand out for their extremely high levels of flexibility when it comes to air delivery volumes, guaranteeing a high level of efficiency across the whole air delivery range.



Perfect teamwork - IES2

In the case of compressors with variable speed control, motor and frequency converter must work together in harmony in order to operate efficiently. For this reason, KAESER selects SIEMENS motors with specifically-matched frequency converters so as to guarantee perfect interplay at the highest levels of efficiency – IES 2.



Combined with a high-performance frequency converter

The Siemens frequency converter has a control algorithm specifically adapted to the motor. With a finely tuned combination of frequency converter and drive motor, KAESER achieves the highest system efficiency class.



Resource-conserving and service-friendly

The synchronous reluctance motors fitted by KAESER are built specifically to conserve resources. Specially-formed magnetic steel sheets replace aluminium, copper and expensive rare earth materials. This makes the drive not only highly durable, but also service-friendly.

SIGMA CONTROL® 2 and SIGMA AIR MANAGER® 4.0

Perfect interplay



SIGMA CONTROL 2: Optimum efficiency

The internal SIGMA CONTROL 2 controller ensures efficient compressor control and monitoring at all times. The large display and RFID reader provide easy communication and maximum security. Variable interfaces enable seamless networking capability, whilst the SD card slot makes updates quick and easy.



Integrated web server

The SIGMA CONTROL 2 is equipped with its own web server, making it possible to visualise compressor status via intranet or Internet. Operational data and maintenance/ alarm messages can therefore be viewed, with password protection, from any PC running a standard Internet browser. This feature benefits users considerably by simplifying operation and maintenance.



SIGMA AIR MANAGER 4.0

This powerful master controller provides efficient control and coordinated management of up to 16 pieces of compressed air supply equipment, whilst also monitoring the associated air treatment components. The SIGMA AIR MANAGER 4.0 also ensures full compatibility of all KAESER compressed air supply systems within an Industrie 4.0 environment.



KAESER CONNECT

The SIGMA AIR MANAGER 4.0's integrated web server provides visual display of all compressed air system data in the form of HTML pages. The information is available any time, anywhere, and can be visualised in real-time on all network-capable devices.

Service...

...virtually maintenance-free



(1) Hydraulic inlet valve

The hydraulically operated inlet valves in KAESER oil-free compression rotary screw compressors are unaffected by contaminants and condensate. This enhances their reliability and ease of maintenance when compared to pneumatic valves.



(2) Fibre-free pulse dampers

KAESER's new fibre-free pulse dampers keep pressure losses to an absolute minimum, help maintain consistent air quality and minimise unwanted vibrations. In addition, their fibre-free design reliably eliminates the possibility of compressed air contamination.



Image: CSG 120-2 RD SFC W

...excellent accessibility



(3) Easy-access coupling

The electric motor directly drives the airend via a maintenance-free coupling, which virtually eliminates transmission losses. Since there is no need for complicated disassembly work, the easy-access coupling can be replaced quickly and simply.



(4) High-efficiency condensate separator

Thanks to its flow-optimised design, the newly developed condensate separator reliably separates the condensate downstream from the air coolers – with minimal pressure loss.





Image: CSG 120-2 RD SFC, person shown 1.80 m tall

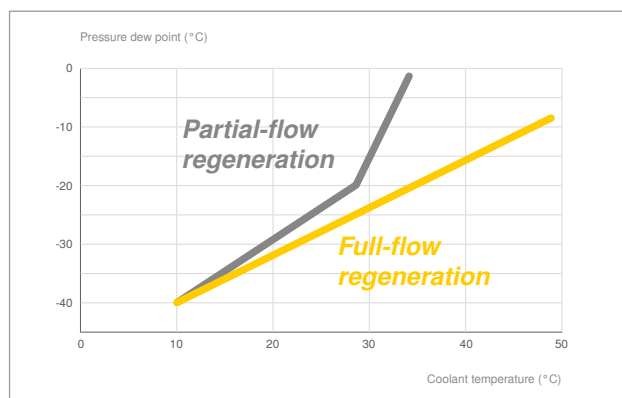
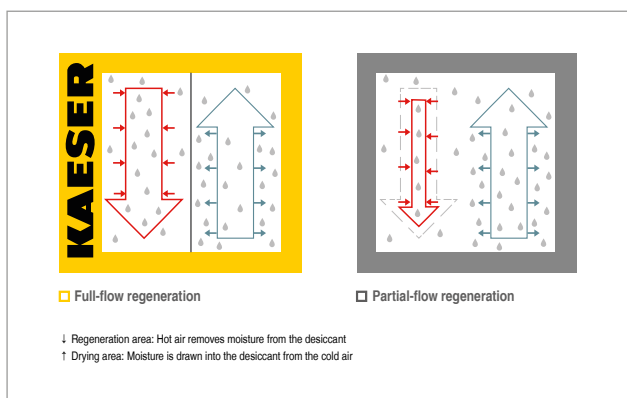

Full-flow regeneration in detail

The i.HOC (Integrated Heat of Compression Dryer) system uses 100 % of the heat of compression from the second compression stage for drying purposes (full-flow regeneration). This heat, which is produced in any case, is therefore effectively available at zero cost.

Drying even near the limit

The advantages of full-flow regeneration become obvious, especially with increased coolant temperatures. KAESER rotation dryers achieve outstanding drying results, even without additional electrical heating of the regeneration air.



i.HOC

Dependable pressure dew points thanks to innovative process engineering

The patented i.HOC rotation dryer from KAESER uses up to 100 % of the heat created during the compression process. Thanks to this full-flow regeneration method, these dryers deliver reliable pressure dew points up to an ambient temperature of +45 °C – without any electrical heating or additional cooling of the regeneration air! Air and water-cooled versions are available.

The benefits:

- Dependable sub-zero pressure dew points even at high ambient or coolant temperatures.
- Pressure dew point stability even at lowest compressor load – without any need for a partial load compensator.
- Available with pressure dew point control if required.
- Highly effective, simultaneous drying and heat recovery with water-cooled compressors.



Perfect performance

The i.HOC's intelligent control ensures pressure dew point stability, even with fluctuating flow rates and at partial compressor loads. When commissioned, the target pressure dew point is reached after just one rotation of the drum.

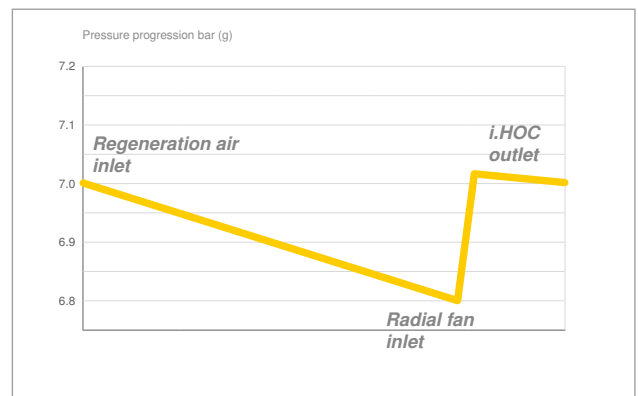

Pressure loss? On the contrary!

The radial fan in the base of the i.HOC equalises drying process pressure losses as required, thereby guaranteeing maximum pressure dew point stability and quality - the pressure at the i.HOC dryer outlet is even higher than that at the inlet.

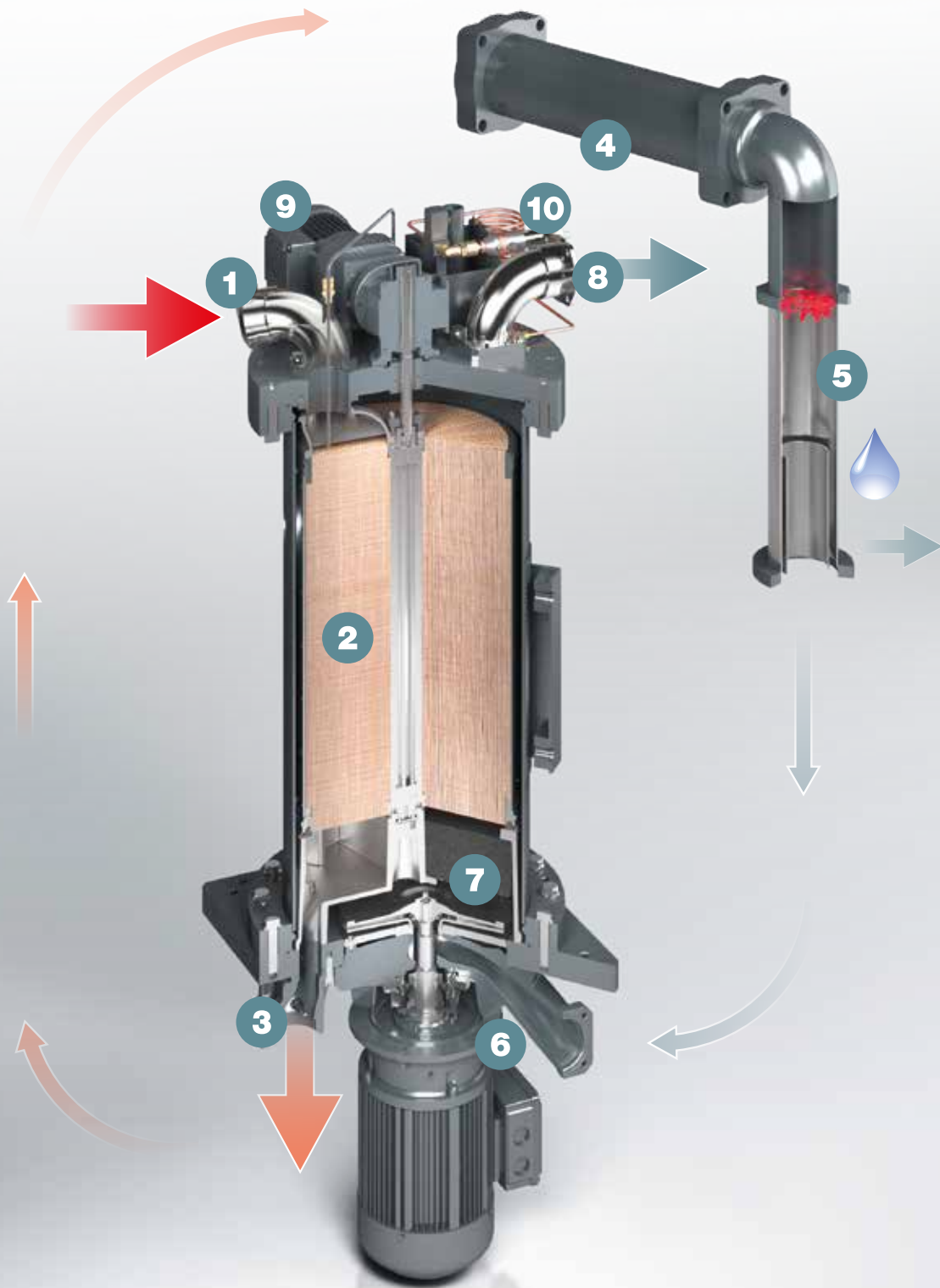

Image: RD 130 rotation dryer

- | | |
|-----------------------------|---|
| (1) Regeneration air inlet | (6) Radial fan |
| (2) Drum | (7) Demister |
| (3) Regeneration air outlet | (8) i.HOC rotation dryer outlet |
| (4) Heat exchanger stage 2 | (9) Drum motor |
| (5) Condensate separator | (10) Pressure dew point sensor (optional) |

i.HOC

Precision operation for efficiency and low pressure dew points



Precision drum

The silica gel desiccant is bedded in a precision-manufactured drum with exceptionally high run-out qualities. Incorrect flow within the dryer and the resulting pressure dew point fluctuations are therefore reliably prevented.



Variable-speed drum motor

Drum speed is automatically adjusted according to actual compressor performance, so as to regenerate the desiccant as effectively as possible. This is the key to ensuring consistently low pressure dew points.



Durable and efficient

Thanks to CFD optimisation, the flow-optimised radial fan installed in the base of the dryer efficiently compensates for the pressure losses in the i.HOC cooling path.

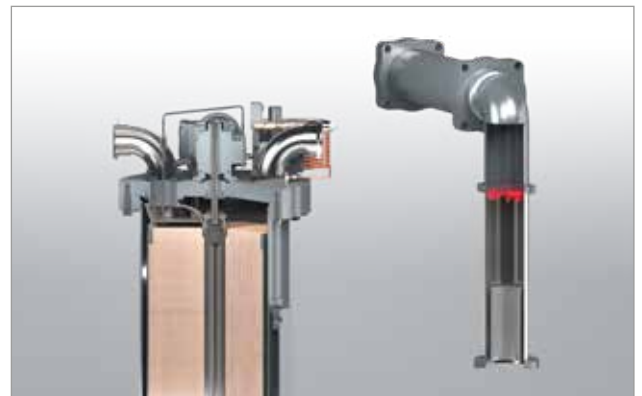

External condensate separation

The i.HOC system uses a highly efficient condensate separator downstream from the heat exchanger in the second compression stage, so as to separate the condensate formed during the regeneration process **outside the dryer**. This protects the drum from potentially damaging water droplets.



Cleaning made simple

Thorough cleaning of the air aftercoolers does not require the use of a crane – they can simply be swung out by a service technician. Cleaning can then be carried out quickly and easily beside the machine, without the risk of contaminating the interior of the compressor unit.



Capable of operation in ambient temperatures up to +45 °C as standard

Air-cooled machines operate dependably in ambient temperatures up to +45 °C thanks to their durable and energy-efficient radial fan.



Air-cooling

Dependable performance – even under extreme conditions

The benefits:

- No cooling-water infrastructure is required.
- Meticulously designed machines with logical component layout make maintenance and service work quick and easy.
- The heated cooling air can easily be re-used for space-heating purposes.

◀ Image: FSG 420-2 A



Outstanding durability through pre-cooling

Highly effective pre-cooling with a stainless steel tube cooler on the high pressure side ensures outstanding air cooler durability. Furthermore, this robust cooler combination also delivers comparably low compressed air discharge temperatures.



Energy-saving standstill fan

When the large radial fan in air-cooled units is switched off as part of the transition to standby mode, the energy-saving, temperature-controlled standstill fan reliably removes the remaining heat from the compressor.

Water-cooling

Compact energy-savers

The benefits:

- Exceptionally low compressed air discharge temperature thanks to high-quality separate air cooler.
- Load-dependent cooling-water control for optimum compressor cooling and simultaneous efficient use of cooling water.
- Compact and low-standing design.

Image: FSG 420-2 i.HOC W SFC ▶



Parallel heat exchanger

Both the low and high pressure stages of KAESER's water-cooled, oil-free compression rotary screw compressors are equipped with their own dedicated parallel heat exchanger for enhanced heat transfer. This optimised cooling consequently improves specific power performance.



Optimised water cooler

KAESER's water-cooled, oil-free compression rotary screw compressors feature highly efficient air/water heat exchangers. CuNi10Fe cooling pipes with internal star lamella fins provide optimum heat transfer and lowest possible compressed air discharge temperatures with minimal pressure loss.

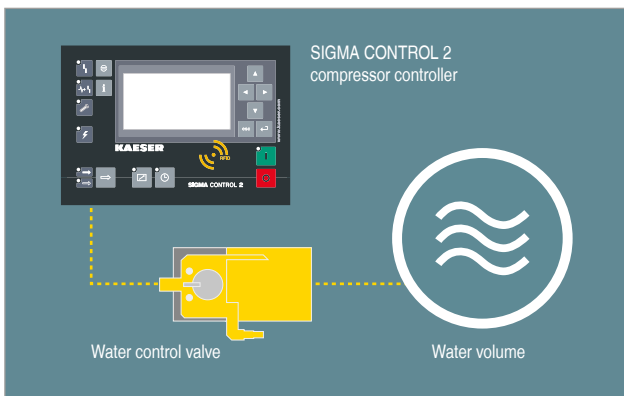

Clever control

KAESER's water-cooled, oil-free compression rotary screw compressors feature sealed water control valves that are actuated via the advanced SIGMA CONTROL 2 compressor controller, which precisely adjusts water volume to meet actual load requirement.



Permanent adjustment

The important but time-consuming task of performing hydraulic adjustment of both air coolers is carried out permanently and automatically during commissioning and when the machine is in operation. Cooling performance is therefore optimally matched to the operating conditions.

Why recover heat?

In fact, the question should be: Why not?

You will not only reduce your company's primary energy consumption, but also improve its CO₂ balance.

Compressors with air-cooling

Compressed air users need to develop clever ideas regarding the use of warm exhaust air from their compressors. KAESER has the long-standing expertise to help you with all you need to know in this regard and will stand side-by-side with you every step of the way.

Compressors with water-cooling

Thanks to the compact heat recovery module integrated into the compressor, generating hot water for production or auxiliary heating purposes could not be simpler. Cost and space-intensive external infrastructure is not necessary with KAESER solutions and the amortisation period of the heat recovery module is usually less than a year (see example calculation below).



Example amortisation calculation	
Inlet temperature	20 °C
Relative humidity	30 %
Cooling water inlet (primary)	20 °C
Cooling water outlet (primary)	80 °C
Compressor power consumption CSG-130-2 10 bar (g)	96.8 kW
Heat recovery potential relative to total power consumption	87 %
Recoverable heat capacity	84.2 kW
Annual operating hours	6,000 hrs
Kilowatt hours per year	505,296 kWh
Fuel costs	0.02 €/kWh
Annual fuel cost savings	€ 10,105
Amortisation period	< 1 year

Amortisation period < 1 year

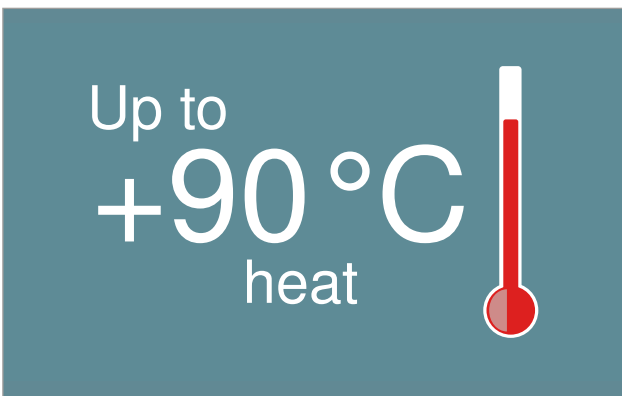

Process, heating and service water

Compressor exhaust heat can be used to produce hot water with temperatures up to +90 °C, which can then be used for a wide range of applications.



Space heating with warm exhaust air

Heating made simple: thanks to radial fans with high residual thrust, the reusable (warm) air from KAESER's air-cooled rotary screw compressors can easily be ducted away to spaces that require heating – usually without the need for additional fans.

Technical implementation of integrated heat recovery

Water-cooled version with heat recovery

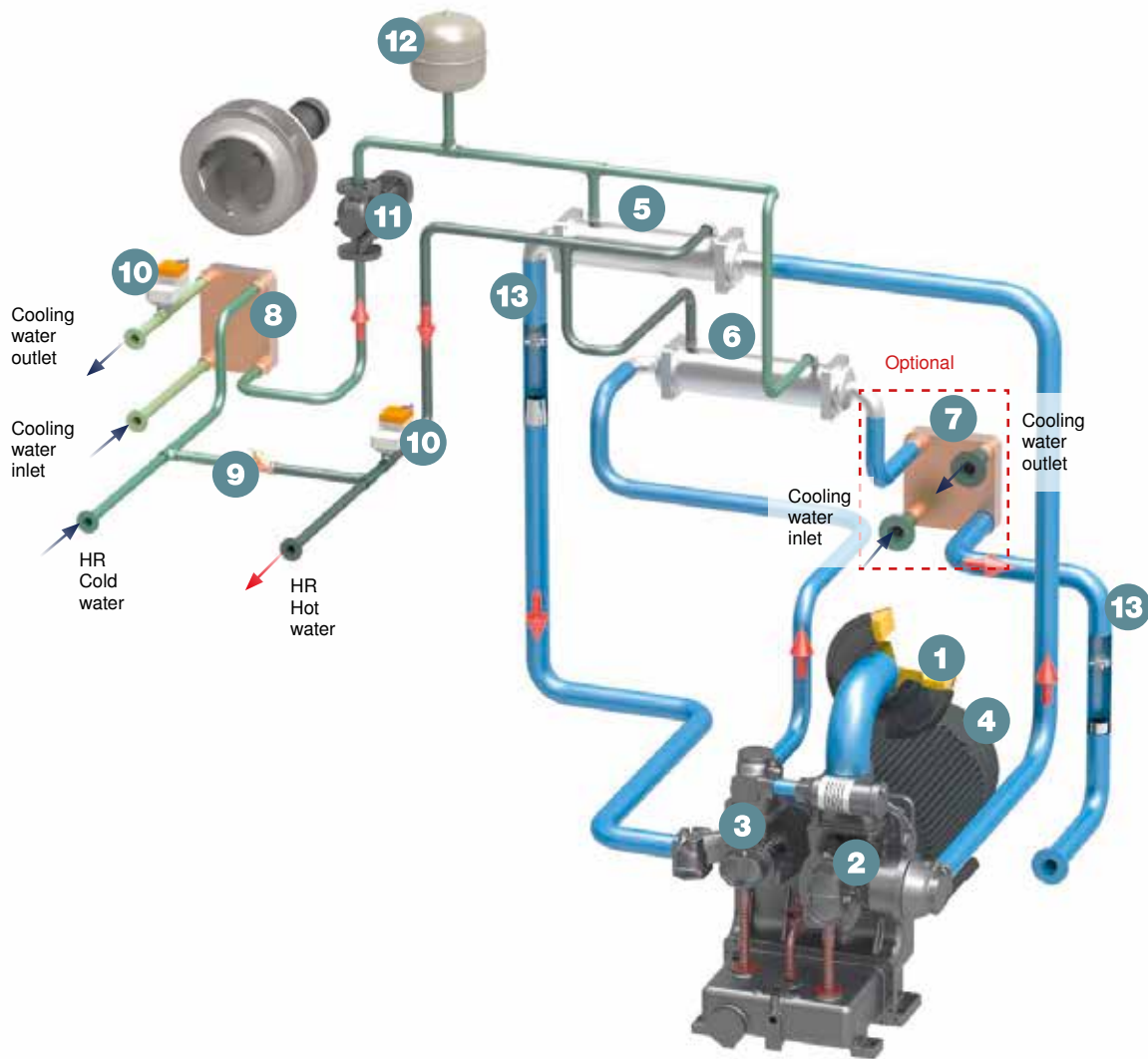

- | | |
|--|---|
| (1) Inlet filter | (8) Heat exchanger (water/water) |
| (2) Low pressure stage (Stage 1) | (9) Check valve |
| (3) High pressure stage (Stage 2) | (10) Water control valve
(actuated by SIGMA CONTROL) |
| (4) Drive motor | (11) Pump |
| (5) Air cooler downstream from Stage 1 (air/water) | (12) Expansion tank |
| (6) Air cooler downstream from Stage 2 (air/water) | (13) Condensate separator |
| (7) Optional additional heat exchanger (air/water)
→ Version as plate-type heat exchanger | (14) Integrated i.HOC rotation dryer |

In two-stage oil-free compression rotary screw compressors, some 90 % of the usable heat is processed through the two air coolers (5) and (6).

KAESER therefore uses separate, high-quality heat exchangers developed specially to meet heat recovery requirements. The remaining 10 % of usable heat is processed through the oil cooler and in the jacket cooling system of the compression stages.



Versions with rotation dryer

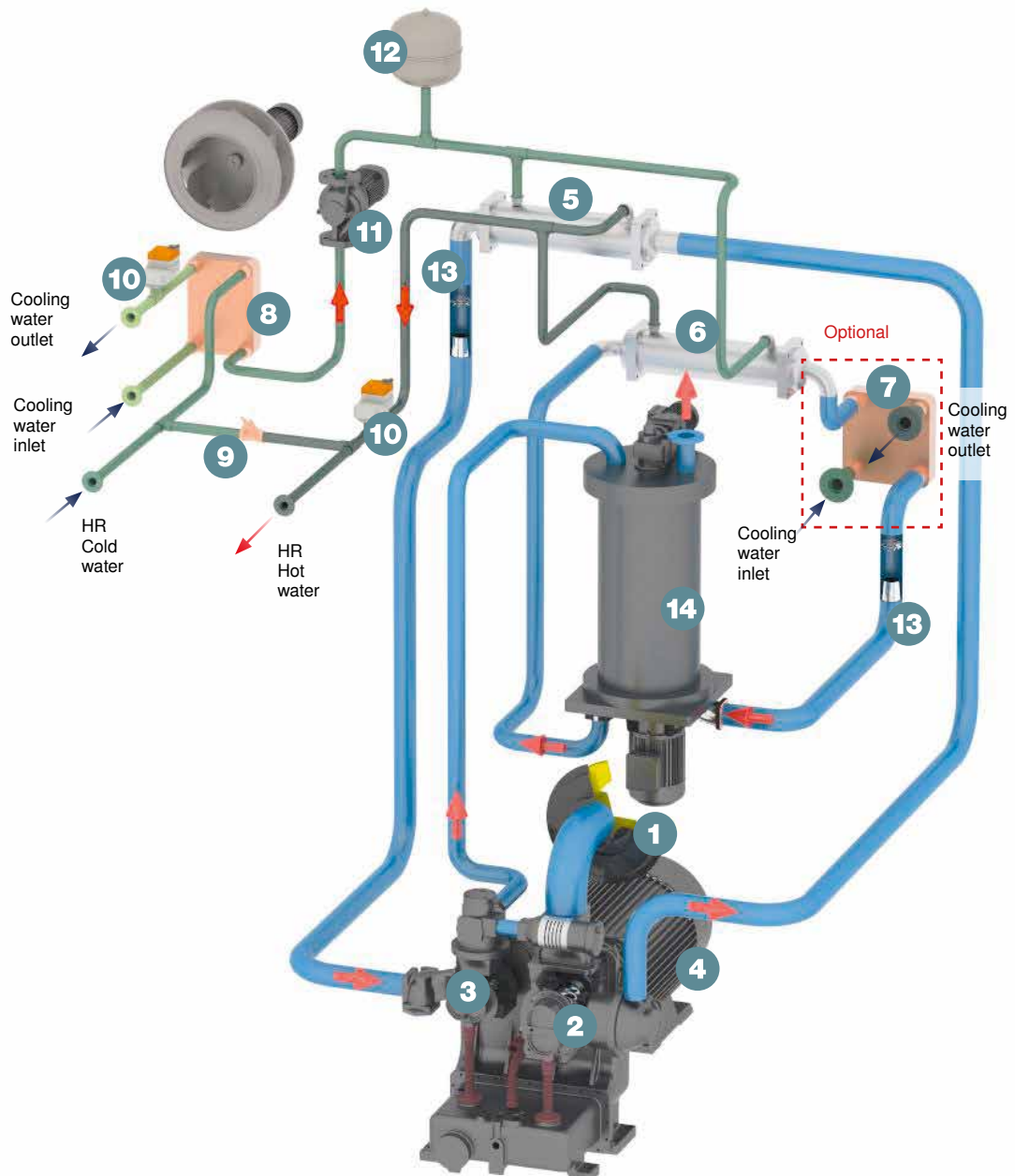

Compressed air drying process – Overview

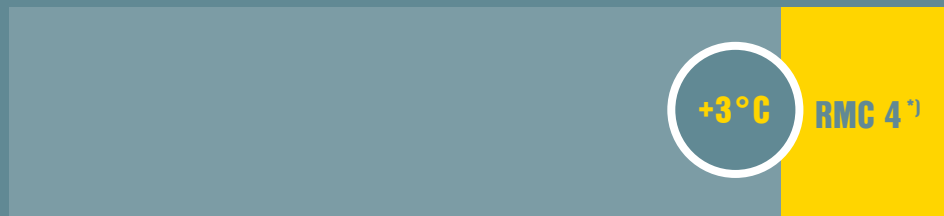

Refrigeration dryer

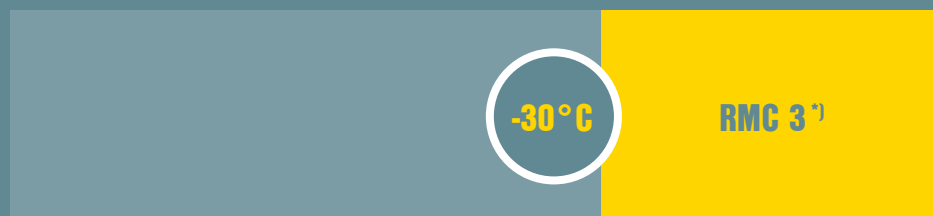

I.HOC rotation dryer

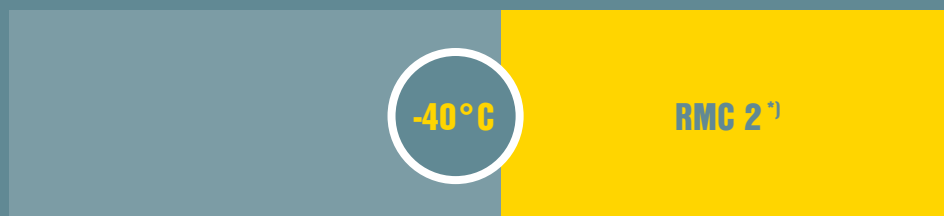

Combination dryer



Desiccant dryer

 Residual moisture in the compressed air following drying. ¹⁾ RMC = Residual Moisture Class

Precision analysis essential

The required pressure dew point plays a significant role in determining the drying process, as well as the investment, service and energy costs associated with compressed air drying.

It is therefore highly recommended to carry out a detailed system analysis. Unnecessarily high compressed air volume creates additional costs, which is something that we will gladly help you avoid!



Refrigeration dryer

For oil-free compression rotary screw compressors, refrigeration dryers are the go-to choice for delivering best possible energy efficiency and favourable investment costs when pressure dew points down to **+3 °C** are required. Pressure dew points below **+3 °C** are provided by desiccant dryers.

i.HOC rotation dryer

Integrated into the rotary screw compressor, the optional i.HOC rotation dryer can reliably and efficiently deliver pressure dew points down to **-30 °C**. The hot compressed air from the second compression stage is used to regenerate the desiccant.



Combination dryer

HYBRITEC dryers combine the energy-saving operation of modern refrigeration dryers with the ultra-low pressure dew points of desiccant dryers. HYBRITEC dryers can deliver pressure dew points as low as **-40 °C** with exceptional efficiency.



Heatless regenerating desiccant dryer

KAESER'S DC series heatless regenerating desiccant dryers deliver pressure dew points as low as **-70 °C**, even under extreme operating conditions.

Integrated refrigeration drying

KAESER refrigeration dryers ensure dry compressed air that is perfectly suited for the intended application and all flow rates. With these high-quality industrial machines, you will be providing reliable protection against condensate damage for your systems and processes, even under the harshest of conditions (CSG series).



Energy-saving drying

An integrated design, together with the generously-dimensioned aluminium block heat exchanger, helps ensure a minimal pressure loss of less than 0.1 bar. The energy-saving scroll refrigerant compressor helps to achieve additional compressed air energy savings.



Excellent accessibility

All refrigeration dryer components are perfectly accessible via the service door on the front of the unit. Dryer service and maintenance work is therefore a breeze.





Image: CSG 120-2 T SFC A

Technical specifications

Air-cooled CSG packages

Rated motor power kW	Model	Gauge pressure bar	Standard			SFC with synchronous reluctance motor		
			Flow rate ¹⁾ m ³ /min	Mass kg	Sound pressure level ²⁾ dB(A)	Flow rate ¹⁾ m ³ /min	Mass kg	Sound pressure level ²⁾ dB(A)
37	CSG 55-2 CSG 55-2 T CSG 55-2 i.HOC	6	Upon request	2270	71	-	-	-
		8	5.4	2520				
		10	-	2985				
45 ³⁾	CSG 70-2 CSG 70-2 T CSG 70-2 i.HOC	6	7.77	2310	71	3.12 - 7.71	2360	71
		8	6.69	2560		3.47 - 6.62	2610	
		9	-	3025		3.62 - 6.05	3080	
55	CSG 90-2 CSG 90-2 T CSG 90-2 i.HOC	6	9.62	2375	72	3.23 - 9.58	2360	72
		8	8.8	2625		3.47 - 8.32	2610	
		9	7.67	3090		3.62 - 7.77	3080	
75	CSG 120-2 CSG 120-2 T CSG 120-2 i.HOC	6	12.92	2515	73	4.51 - 12.41	2400	73
		8	12	2765		3.98 - 11.30	2650	
		10	10.43	3230		4.81 - 10.10	3120	
90	CSG 130-2 CSG 130-2 T CSG 130-2 i.HOC	6	12.92	2640	74	4.64 - 13.41	2480	74
		8	12.88	2890		5.05 - 13.30	2730	
		10	12.85	3355		5.47 - 12.70	3200	

Air-cooled DSG packages

Rated motor power kW	Model	Gauge pressure bar	Standard			SFC		
			Flow rate ¹⁾ m ³ /min	Mass kg	Sound pressure level ²⁾ dB(A)	Flow rate ¹⁾ m ³ /min	Mass kg	Sound pressure level ²⁾ dB(A)
90	DSG 140-2 DSG 140-2 i.HOC	8	13.18	3400	77	-	-	-
		10	13.12	4500				
110	DSG 180-2 DSG 180-2 i.HOC	6	19.2	3550	78	9.46 - 20.79	4150	79
		8	18.4	4650		8.51 - 18.56	5250	
		10	16.1			9.54 - 16.43		
132	DSG 220-2 DSG 220-2 i.HOC	6	23	3700	78	8.68 - 22.45	4300	79
		8	21.6	4800		9.51 - 21.8	5400	
		10	19.1			9.95 - 19.5		
160	DSG 260-2 DSG 260-2 i.HOC	6	26.1	3850	79	9.36 - 27.66	4450	80
		8	26	495		9.62 - 25.44	5550	
		10	22.9			10.3 - 23.3		
200	DSG 290-2 DSG 290-2 i.HOC	6	28.55	4000	81	10.27 - 30.05	4600	82
		8	28.5	5100		11.47 - 30	5700	
		10	26			12.33 - 28		

Air-cooled FSG packages

Rated motor power kW	Model	Gauge pressure bar	Standard			SFC with synchronous reluctance motor		
			Flow rate ¹⁾ m ³ /min	Mass kg	Sound pressure level ²⁾ dB(A)	Flow rate ¹⁾ m ³ /min	Mass kg	Sound pressure level ²⁾ dB(A)
160	FSG 300-2 FSG 300-2 i.HOC	6 8	29.4 29.3	5550 6750	78	-	-	-
200	FSG 350-2 FSG 350-2 i.HOC	6 8 10	37.3 34.9 29.2	5750 6950	79	-	-	-
250	FSG 420-2 FSG 420-2 i.HOC	6 8 10	45.7 42 37.1	5950 7150	80	14.79 - 44.56 16.63 - 40.57 18.48 - 36.54	6550 7750	81
315	FSG 450-2 FSG 450-2 i.HOC	6 8	45.6 41.9	6250 7450	81	-	-	-
315	FSG 500-2 FSG 500-2 i.HOC	6 8 10	- 50 45.6	6250 7450	82	16.94 - 50.7 18.41 - 47.53 19.88 - 43.57	6550 7750	83
355	FSG 520-2 FSG 520-2 i.HOC	6 8 10	-	-	-	16.94 - 50.7 18.41 - 50.63 19.88 - 48.59	7600 8800	84

Dimensions for standard and SFC versions

Model	Dimensions W x D x H Standard/SFC mm
CSG-2 CSG-2 T CSG-2 i.HOC	2490 x 1660 x 2145 2840 x 1660 x 2145 3140 x 1660 x 2145
DSG-2 DSG-2 i.HOC	3435 x 1750 x 2385 4270 x 1750 x 2385
FSG-2 FSG-2 i.HOC	3860 x 2075 x 2730 4630 x 2075 x 2730



¹⁾ Flow rate complete system as per ISO 1217: 2009, Annexe C/E, inlet pressure 1 bar (a), cooling and inlet air temperature +20 °C, rel. humidity 0%

²⁾ Sound pressure level as per ISO 2151 and basic standard ISO 9614-2, tolerance: ± 3 dB (A)

³⁾ CSG 70-2 SFC: Version with rated motor power 55 kW

Specifications subject to change without notice.

Technical specifications

Water-cooled CSG packages

Rated motor power kW	Model	Gauge pressure bar	Standard			SFC with synchronous reluctance motor		
			Flow rate ¹⁾ m ³ /min	Mass kg	Sound pressure level ²⁾ dB(A)	Flow rate ¹⁾ m ³ /min	Mass kg	Sound pressure level ²⁾ dB(A)
37	CSG 55-2 CSG 55-2 T CSG 55-2 i.HOC	6	Upon request	2270	64	-	-	-
		8	5.4	2520				
		10	-	2985				
45 ³⁾	CSG 70-2 CSG 70-2 T CSG 70-2 i.HOC	6	7.92	2310	64	3.03 - 8.03	2360	64
		8	6.82	2560		3.03 - 6.98	2610	
		10	Upon request	3025		3.71 - 6.00	3080	
55	CSG 90-2 CSG 90-2 T CSG 90-2 i.HOC	6	9.78	2375	65	3.62 - 9.90	2360	65
		8	8.97	2625		3.84 - 8.70	2610	
		10	7.83	3090		3.96 - 7.67	3080	
75	CSG 120-2 CSG 120-2 T CSG 120-2 i.HOC	6	13.07	2515	66	4.18 - 12.74	2400	66
		8	12.15	2765		4.21 - 11.69	2650	
		10	10.58	3230		4.23 - 10.63	3120	
90	CSG 130-2 CSG 130-2 T CSG 130-2 i.HOC	6	-	2640	68	4.33 - 13.51	2480	68
		8	13.03	2890		4.26 - 13.54	2730	
		10	13.00	3355		4.20 - 13.08	3200	

Water-cooled DSG packages

Rated motor power kW	Model	Gauge pressure bar	Standard			SFC		
			Flow rate ¹⁾ m ³ /min	Mass kg	Sound pressure level ²⁾ dB(A)	Flow rate ¹⁾ m ³ /min	Mass kg	Sound pressure level ²⁾ dB(A)
90	DSG 140-2 DSG 140-2 i.HOC	8	13.18	3100	69	-	-	-
		10	13.12	4200				
110	DSG 180-2 DSG 180-2 i.HOC	6	19.2	3250	70	9.46 - 20.79	3850	71
		8	18.4	4350		8.51 - 18.56	4950	
		10	16.1			9.54 - 16.43		
132	DSG 220-2 DSG 220-2 i.HOC	6	23	3400	71	8.68 - 22.45	4000	72
		8	21.6	4500		9.51 - 21.8	5100	
		10	19.1			9.95 - 19.5		
160	DSG 260-2 DSG 260-2 i.HOC	6	26.1	3550	74	9.36 - 27.66	4150	75
		8	26	4650		9.62 - 25.44	5250	
		10	22.9			10.3 - 23.3		
200	DSG 290-2 DSG 290-2 i.HOC	6	28.55	3700	75	10.27 - 30.05	4300	76
		8	28.5	4800		11.47 - 30	5400	
		10	26			12.33 - 28		

Water-cooled FSG packages

Rated motor power kW	Model	Gauge pressure bar	Standard			SFC		
			Flow rate ¹⁾ m ³ /min	Mass kg	Sound pressure level ²⁾ dB(A)	Flow rate ¹⁾ m ³ /min	Mass kg	Sound pressure level ²⁾ dB(A)
160	FSG 300-2 FSG 300-2 i.HOC	6 8	29.4 29.3	5250 6400	74	-	-	-
200	FSG 350-2 FSG 350-2 i.HOC	6 8 10	37.3 34.9 29.2	5450 6600	75	-	-	-
250	FSG 420-2 FSG 420-2 i.HOC	6 8 10	45.7 42 37.1	5650 6800	75	14.79 - 44.56 16.63 - 40.57 18.48 - 36.54	6250 7400	76
315	FSG 450-2 FSG 450-2 i.HOC	6 8	45.6 41.9	5950 7100	75	-	-	-
315	FSG 500-2 FSG 500-2 i.HOC	6 8 10	- 50 45.6	5950 7100	76	16.94 - 50.7 18.41 - 47.53 19.88 - 43.57	6700 7850	77
355	FSG 520-2 FSG 520-2 i.HOC	6 8 10	- - 50	6550 7700	77	16.94 - 50.7 18.41 - 50.64 19.88 - 50.57	7300 8450	78

Dimensions for standard and SFC versions

Model	Dimensions W x D x H mm
CSG-2 CSG-2 T CSG-2 i.HOC	2490 x 1660 x 1965 2840 x 1660 x 1965 3140 x 1660 x 1965
DSG-2 DSG-2 i.HOC	3435 x 1750 x 2060 4270 x 1750 x 2060
FSG-2 FSG-2 i.HOC	3650 x 2075 x 2730 4475 x 2075 x 2220



¹⁾ Flow rate complete system as per ISO 1217: 2009, Annexe C/E, inlet pressure 1 bar (a), cooling and inlet air temperature +20 °C, rel. humidity 0%

²⁾ Sound pressure level as per ISO 2151 and basic standard ISO 9614-2, tolerance: ± 3 dB (A)

³⁾ CSG 70-2 SFC: Version with rated motor power 55 kW

Specifications subject to change without notice.

Equipment

Complete system

Oil-free compression rotary screw compressor with two-stage compression; condensate separator, condensate drain and fibre-free pulse dampers for both compression stages; oil tank ventilation with microfilter, ready to operate, fully automatic, silenced.

Airend

Two-stage oil-free compression rotary screw airend with integrated gearing and collection tank for gear oil. Rotors feature durable coating. Both high and low pressure compression stages feature jacket cooling; high pressure stage with chromium steel rotors.

Drive:

Precision gearing as per AGMA Q13/DIN Class 5 with helical spur gears.

Drive motor

Premium Efficiency IE4 drive motor, quality manufacture; IP 55 enclosure protection, Pt100 temperature sensor in windings; continuous measurement and monitoring of motor windings temperature.

Electrical components

Ventilated IP 54 control cabinet, automatic star-delta starter, overload relay, control transformer.

SIGMA CONTROL 2

Full-text display, 30 selectable languages; soft-touch icon keys; "traffic light" style LEDs to indicate operating status; fully automatic monitoring and control; Dual, Quadro and Dynamic control modes selectable as standard; SD card slot for data logging and updates; RFID reader; web server; interfaces: Ethernet; optional communications modules for: Profibus DP, Modbus, Profinet and Devicenet.

Dynamic Control

The dynamic control feature calculates run-on times based on the motor windings temperature. This reduces idling times and energy consumption. Additional control modes are stored in the SIGMA CONTROL 2 and can be called up as required.

Cooling

Air or water-cooling available; radial fan with separate drive motor; exhaust air discharged upwards.

Air-cooled version:

High-pressure side: aluminium cooler with stainless steel tube pre-cooler. Low pressure side: aluminium cooler; aluminium cooler for cooler oil.

Water-cooled version:

Two shell and tube heat exchangers comprising coated steel jacket and pipes made from CuNi10Fe; one gear oil cooler.

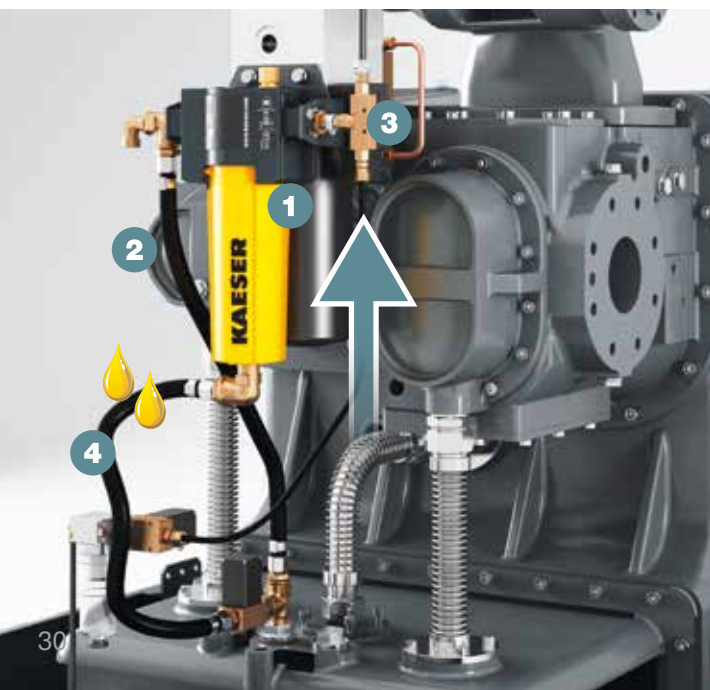

Dependable oil reservoir venting

The microfilter in the oil reservoir venting system prevents intake of oil-laden air. This is another key detail to ensure that compressed air quality is reliably and efficiently maintained at all times.

- (1) Microfilter
- (2) Oil mist removal
- (3) Ejector
- (4) Return to gear oil reservoir

Options

	Model	Air-cooled	Water-cooled
Adjustable machine feet	CSG-2 DSG-2 FSG-2	● ● ●	● ● ●
Silencer, air inlet opening (Sound-insulated connecting links upstream from heat exchangers)	CSG-2 DSG-2 FSG-2	● ● ●	– – –
Cooling-air filter mats (Protects the heat exchanger against heavy contamination)	CSG-2 DSG-2 FSG-2	● ● ●	– – –
Integrated heat recovery with pump (Compressor is equipped with a complete second auxiliary water system, including water pump. This protects the compressor against excessive temperatures.)	CSG-2 DSG-2 FSG-2	– – –	● ● ●
Integrated heat recovery without pump (Compressor is equipped with a second auxiliary water system, without water pump. This protects the compressor against excessive temperatures.)	CSG-2 DSG-2 FSG-2	– – –	● ● ●
Auxiliary heat exchanger downstream from air cooler, 2nd stage (Reduces the compressed air discharge temperature in compressors with heat recovery. Improves the pressure dew point for compressors with i.HOC.)	CSG-2 DSG-2 FSG-2	– – –	● ● ●
Integrated heat exchanger downstream from i.HOC rotation dryer (Reduces the compressed air discharge temperature from the compressor in packages with integrated i.HOC.)	CSG-2 DSG-2 FSG-2	● ● ●	● ● ●
Pressure dew point measurement (Pressure dew point sensor installed.)	CSG-2 DSG-2 FSG-2	● ● ●	● ● ●
Pressure dew point adjustment (Controlled bypass around the stage 1 heat exchanger to improve pressure dew point as needed.)	CSG-2 DSG-2 FSG-2	● ● ●	● ● ●
Pressure dew point control (Pressure dew point measurement and controlled bypass around the stage 1 heat exchanger to improve pressure dew point as needed.)	CSG-2 DSG-2 FSG-2	● ● ●	● ● ●
KAESER hot air control (Bypass around the stage 1 heat exchanger to increase compressed air temperature after leaving the 2nd stage, as needed. No heat exchanger installed downstream from the 2nd stage.) <i>Not available for packages with integrated rotation or refrigeration dryer.</i>	CSG-2 DSG-2 FSG-2	● ● ●	● ● ●
Vibration measurement (Monitoring of the bearings on the motor and compressor. Warning and fault levels are programmed in the controller).	CSG-2 DSG-2 FSG-2	● ● ●	● ● ●

- Available
- Not available

The world is our home

As one of the world's largest manufacturers of compressors, blowers and compressed air systems, KAESER KOMPRESSOREN is represented throughout the world by a comprehensive network of branches, subsidiaries and authorised distribution partners in over 140 countries.

By offering innovative, efficient and reliable products and services, KAESER KOMPRESSOREN's experienced consultants and engineers work in close partnership with customers to enhance their competitive edge and to develop progressive system concepts that continuously push the boundaries of performance and technology. Moreover, decades of knowledge and expertise from this industry-leading systems provider are made available to each and every customer via the KAESER group's advanced global IT network.

These advantages, coupled with KAESER's worldwide service organisation, ensure that every product operates at peak performance at all times, whilst providing maximum availability.



KAESER KOMPRESSOREN SE

P.O. Box 2143 – 96410 Coburg – GERMANY – Tel +49 9561 640-0 – Fax +49 9561 640-130
E-mail: productinfo@kaeser.com – www.kaeser.com